



# Low-Power, Precision SINGLE-SUPPLY OPERATIONAL AMPLIFIERS

## FEATURES

- **WIDE SUPPLY RANGE:**  
Single Supply:  $V_S = +2.7V$  to  $+36V$   
Dual Supply:  $V_S = \pm 1.35V$  to  $\pm 18V$
- **SPECIFIED PERFORMANCE:**  
 $+2.7V$ ,  $+5V$ , and  $\pm 15V$
- **LOW QUIESCENT CURRENT:**  $250\mu A/amp$
- **LOW INPUT BIAS CURRENT:**  $25nA$  max
- **LOW OFFSET VOLTAGE:**  $100\mu V$  max
- **HIGH CMRR, PSRR, and  $A_{OL}$**
- **SINGLE, DUAL, and QUAD VERSIONS**

## DESCRIPTION

The OPA234 series low-cost op amps are ideal for single-supply, low-voltage, low-power applications. The series provides lower quiescent current than older "1013"-type products and comes in current industry-standard packages and pinouts. The combination of low offset voltage, high common-mode rejection, high power-supply rejection, and a wide supply range provides excellent accuracy and versatility. Single, dual, and quad versions have identical specifications for maximum design flexibility. These general-purpose op amps are ideal for portable and battery-powered applications.

The OPA234 series op amps operate from either single or dual supplies. In single-supply operation, the input common-mode range extends below ground and the output can swing to within 50mV of ground. Excellent phase margin makes the OPA234 series ideal for demanding applications, including high load capacitance. Dual and quad designs feature completely independent circuitry for lowest crosstalk and freedom from interaction.

Single version packages are in an SO-8 surface-mount and a space-saving MSOP-8 surface-mount. Dual packages are in an SO-8 surface-mount. Quad packages are in an SO-14 surface-mount. All are specified for  $-40^\circ C$  to  $+85^\circ C$  operation.

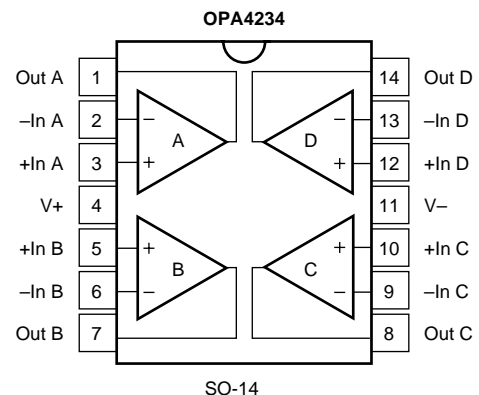
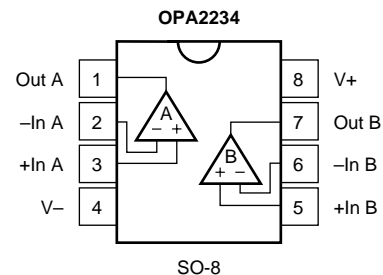
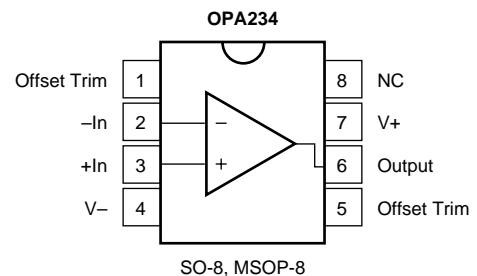

Please be aware that an important notice concerning availability, standard warranty, and use in critical applications of Texas Instruments semiconductor products and disclaimers thereto appears at the end of this data sheet.

All trademarks are the property of their respective owners.

# ELECTRICAL CHARACTERISTICS: $V_S = +5V$

At  $T_A = 25^\circ C$ ,  $V_S = +5V$ ,  $R_L = 10k\Omega$  connected to  $V_S/2$ , and  $V_{OUT} = V_S/2$ , unless otherwise noted.

PARAMETER	CONDITION	OPA234U, E OPA2234U			OPA234UA, EA OPA2234UA OPA4234UA, U			UNITS
		MIN	TYP	MAX	MIN	TYP	MAX	
<b>OFFSET VOLTAGE</b> Input Offset Voltage OPA234E, EA vs Temperature <sup>(1)</sup> vs Power Supply vs Time Channel Separation (Dual, Quad)	$V_{OS}$  $dV_{OS}/dT$ PSRR	$V_{CM} = 2.5V$  Operating Temperature Range $V_S = +2.7V$ to $+30V$ , $V_{CM} = 1.7V$		$\pm 40$ $\pm 100$ $\pm 0.5$ 3 0.2 0.3	$\pm 100$ $\pm 150$ $\pm 3$ 10	*	$\pm 250$ $\pm 350$ *	$\mu V$ $\mu V$ $\mu V/^\circ C$ $\mu V/V$ $\mu V/mo$ $\mu V/V$
<b>INPUT BIAS CURRENT</b> Input Bias Current <sup>(2)</sup> Input Offset Current	$I_B$ $I_{OS}$	$V_{CM} = 2.5V$ $V_{CM} = 2.5V$		-15 $\pm 1$	-30 $\pm 5$	*	-50 *	nA nA
<b>NOISE</b> Input Voltage Noise Density Current Noise Density	$v_n$ $i_n$	f = 1kHz		25 80		*	*	$nV/\sqrt{Hz}$ $fA/\sqrt{Hz}$
<b>INPUT VOLTAGE RANGE</b> Common-Mode Voltage Range Common-Mode Rejection	CMRR	$V_{CM} = -0.1V$ to $4V$		-0.1 91	(V+) -1 106	*	*	V dB
<b>INPUT IMPEDANCE</b> Differential Common-Mode		$V_{CM} = 2.5V$			$10^7 \parallel 5$ $10^{10} \parallel 6$	*	*	$\Omega \parallel pF$ $\Omega \parallel pF$
<b>OPEN-LOOP GAIN</b> Open-Loop Voltage Gain	$A_{OL}$	$V_O = 0.25V$ to $4V$ $R_L = 10k\Omega$ $R_L = 2k\Omega$		108 86	120 96	100 *	* *	dB dB
<b>FREQUENCY RESPONSE</b> Gain-Bandwidth Product Slew Rate Settling Time: 0.1% 0.01% Overload Recovery Time	GBW SR	$C_L = 100pF$  G = 1, 3V Step, $C_L = 100pF$ G = 1, 3V Step, $C_L = 100pF$ ( $V_{IN}$ ) (Gain) = $V_S$		0.35 0.2 15 25 16		*	*	MHz V/ $\mu s$ $\mu s$ $\mu s$ $\mu s$
<b>OUTPUT</b> Voltage Output: Positive Negative Positive Negative Short-Circuit Current Capacitive Load Drive (Stable Operation) <sup>(3)</sup>	$I_{SC}$	$R_L = 10k\Omega$ to $V_S/2$ $R_L = 10k\Omega$ to $V_S/2$ $R_L = 10k\Omega$ to Ground $R_L = 10k\Omega$ to Ground  G = +1		(V+) -1 0.25 (V+) -1 0.1	(V+) -0.65 0.05 (V+) -0.65 0.05 $\pm 11$ 1000	*	*	V V V V mA pF
<b>POWER SUPPLY</b> Specified Operating Voltage Operating Voltage Range Quiescent Current (per amplifier)	$I_Q$			+2.7	+5 250	+36 300	*	V V $\mu A$
<b>TEMPERATURE RANGE</b> Specified Range Operating Range Storage Thermal Resistance 8-Pin DIP SO-8 Surface-Mount MSOP-8 Surface-Mount 14-Pin DIP SO-14 Surface-Mount	$\theta_{JA}$			-40 -40 -55		+85 +125 +125	*	$^\circ C$ $^\circ C$ $^\circ C$ $^\circ C/W$ $^\circ C/W$ $^\circ C/W$ $^\circ C/W$ $^\circ C/W$

\* Specifications same as OPA234U, E.

NOTES: (1) Wafer-level tested to 95% confidence level. (2) Positive conventional current flows into the input terminals. (3) See *Small-Signal Overshoot vs Load Capacitance* typical curve.

# ELECTRICAL CHARACTERISTICS: $V_S = +2.7V$

At  $T_A = 25^\circ C$ ,  $V_S = +2.7V$ ,  $R_L = 10k\Omega$  connected to  $V_S/2$ , and  $V_{OUT} = V_S/2$ , unless otherwise noted.

PARAMETER	CONDITION	OPA234U, E OPA2234U			OPA234UA, EA OPA2234UA OPA4234UA, U			UNITS
		MIN	TYP	MAX	MIN	TYP	MAX	
<b>OFFSET VOLTAGE</b>								
Input Offset Voltage OPA234E, EA	$V_{OS}$		$\pm 40$	$\pm 100$		*	$\pm 250$	$\mu V$
vs Temperature <sup>(1)</sup>	$dV_{OS}/dT$		$\pm 100$	$\pm 150$		*	$\pm 350$	$\mu V$
vs Power Supply	PSRR		$\pm 0.5$	$\pm 3$		*	*	$\mu V/^\circ C$
vs Time			3	10		*	20	$\mu V/V$
Channel Separation (Dual, Quad)			0.2			*		$\mu V/mo$
			0.3			*		$\mu V/V$
<b>INPUT BIAS CURRENT</b>								
Input Bias Current <sup>(2)</sup>	$I_B$	$V_{CM} = 1.35V$	-15	-30		*	-50	nA
Input Offset Current	$I_{OS}$	$V_{CM} = 1.35V$	$\pm 1$	$\pm 5$		*	*	n
<b>NOISE</b>		$f = 1kHz$						
Input Voltage Noise Density	$V_n$		25			*		$nV/\sqrt{Hz}$
Current Noise Density	$i_n$		80			*		$fA/\sqrt{Hz}$
<b>INPUT VOLTAGE RANGE</b>								
Common-Mode Voltage Range			-0.1		$(V+) - 1$	*	*	V
Common-Mode Rejection	CMRR	$V_{CM} = -0.1V$ to $1.7V$	91	106		*	*	dB
<b>INPUT IMPEDANCE</b>								
Differential		$V_{CM} = 1.35V$		$10^7 \parallel 5$		*		$\Omega \parallel pF$
Common-Mode				$10^{10} \parallel 6$		*		$\Omega \parallel pF$
<b>OPEN-LOOP GAIN</b>								
Open-Loop Voltage Gain	$A_{OL}$	$V_O = 0.25V$ to $1.7V$ $R_L = 10k\Omega$ $R_L = 2k\Omega$	108 86	125 96		100 86	*	dB dB
<b>FREQUENCY RESPONSE</b>								
Gain-Bandwidth Product	GBW	$C_L = 100pF$		0.35			*	MHz
Slew Rate	SR			0.2			*	$V/\mu s$
Settling Time: 0.1%		$G = 1, 1V$ Step, $C_L = 100pF$		6			*	$\mu s$
0.01%		$G = 1, 1V$ Step, $C_L = 100pF$		16			*	$\mu s$
Overload Recovery Time		$(V_{IN})$ (Gain) = $V_S$		8			*	$\mu s$
<b>OUTPUT</b>								
Voltage Output: Positive		$R_L = 10k\Omega$ to $V_S/2$	$(V+) - 1$	$(V+) - 0.6$		*	*	V
Negative		$R_L = 10k\Omega$ to $V_S/2$	0.25	0.05		*	*	V
Positive		$R_L = 10k\Omega$ to Ground	$(V+) - 1$	$(V+) - 0.65$		*	*	V
Negative		$R_L = 10k\Omega$ to Ground	0.1	0.05		*	*	V
Short-Circuit Current	$I_{SC}$			$\pm 8$		*	*	mA
Capacitive Load Drive (Stable Operation) <sup>(3)</sup>		$G = +1$		1000		*	*	pF
<b>POWER SUPPLY</b>								
Specified Operating Voltage			+2.7	+2.7		*	*	V
Operating Voltage Range					+36	*	*	V
Quiescent Current (per amplifier)	$I_Q$	$I_O = 0$		250	300	*	*	$\mu A$
<b>TEMPERATURE RANGE</b>								
Specified Range			-40		+85	*	*	$^\circ C$
Operating Range			-40		+125	*	*	$^\circ C$
Storage			-55		+125	*	*	$^\circ C$
Thermal Resistance	$\theta_{JA}$							
8-Pin DIP				100			*	$^\circ C/W$
SO-8 Surface-Mount				150			*	$^\circ C/W$
MSOP-8 Surface-Mount				220			*	$^\circ C/W$
14-Pin DIP				80			*	$^\circ C/W$
SO-14 Surface-Mount				110			*	$^\circ C/W$

\* Specifications same as OPA234U, E.

NOTES: (1) Wafer-level tested to 95% confidence level. (2) Positive conventional current flows into the input terminals. (3) See *Small-Signal Overshoot vs Load Capacitance* typical curve.

# ELECTRICAL CHARACTERISTICS: $V_S = \pm 15V$

At  $T_A = 25^\circ C$ ,  $V_S = \pm 15V$ , and  $R_L = 10k\Omega$  connected to ground, unless otherwise noted.

PARAMETER	CONDITION	OPA234U, E OPA2234U			OPA234UA, EA OPA2234UA OPA4234UA, U			UNITS	
		MIN	TYP	MAX	MIN	TYP	MAX		
<b>OFFSET VOLTAGE</b> Input Offset Voltage OPA4234U Model vs Temperature <sup>(1)</sup> vs Power Supply vs Time Channel Separation (Dual, Quad)	$V_{OS}$  $dV_{OS}/dT$ $PSRR$	$V_{CM} = 0V$  Operating Temperature Range $V_S = \pm 1.35V$ to $\pm 18V$ , $V_{CM} = 0V$		$\pm 70$ $\pm 0.5$ 3 0.2 0.3	$\pm 250$ $\pm 5$ 10		* $\pm 70$ * * *	$\pm 500$ $\pm 250$ * 20	$\mu V$ $\mu V$ $\mu V/^\circ C$ $\mu V/V$ $\mu V/mo$ $\mu V/V$
<b>INPUT BIAS CURRENT</b> Input Bias Current <sup>(2)</sup> Input Offset Current	$I_B$ $I_{OS}$	$V_{CM} = 0V$ $V_{CM} = 0V$		-12 $\pm 1$	-25 $\pm 5$		* *	-50 *	nA nA
<b>NOISE</b> Input Voltage Noise Density Current Noise Density	$V_n$ $i_n$	$f = 1kHz$		25 80			* *		$nV/\sqrt{Hz}$ $fA/\sqrt{Hz}$
<b>INPUT VOLTAGE RANGE</b> Common-Mode Voltage Range Common-Mode Rejection	$CMRR$	$V_{CM} = -15V$ to $14V$	(V-) 91	106	(V+) -1	* 86	* *	* *	V dB
<b>INPUT IMPEDANCE</b> Differential Common-Mode		$V_{CM} = 0V$		$10^7 \parallel 5$ $10^{10} \parallel 6$			* *		$\Omega \parallel pF$ $\Omega \parallel pF$
<b>OPEN-LOOP GAIN</b> Open-Loop Voltage Gain	$A_{OL}$	$V_O = -14.5V$ to $14V$	110	120		100	*		dB
<b>FREQUENCY RESPONSE</b> Gain-Bandwidth Product Slew Rate Settling Time: 0.1% 0.01% Overload Recovery Time	GBW SR	$C_L = 100pF$  $G = 1$ , 10V Step, $C_L = 100pF$ $G = 1$ , 10V Step, $C_L = 100pF$ ( $V_{IN}$ ) (Gain) = $V_S$		0.35 0.2 41 47 22			* * * * *		MHz V/ $\mu s$ $\mu s$ $\mu s$ $\mu s$
<b>OUTPUT</b> Voltage Output: Positive Negative Short-Circuit Current Capacitive Load Drive (Stable Operation) <sup>(3)</sup>	$I_{SC}$	$G = +1$	(V+) -1 (V-) +0.5	(V+) -0.7 (V-) +0.15 $\pm 22$ 1000		* *	* * * *		V V mA pF
<b>POWER SUPPLY</b> Specified Operating Voltage Operating Voltage Range Quiescent Current (per amplifier)	$I_Q$	$I_O = 0$	$\pm 1.35$	$\pm 15$ $\pm 275$	$\pm 18$ $\pm 350$	* *	* *	* *	V V $\mu A$
<b>TEMPERATURE RANGE</b> Specified Range Operating Range Storage Thermal Resistance 8-Pin DIP SO-8 Surface-Mount MSOP-8 Surface-Mount 14-Pin DIP SO-14 Surface-Mount	$\theta_{JA}$		-40 -40 -55		+85 +125 +125	* * *	* * *	* * *	$^\circ C$ $^\circ C$ $^\circ C$ $^\circ C/W$ $^\circ C/W$ $^\circ C/W$ $^\circ C/W$ $^\circ C/W$

\* Specifications same as OPA234U, E.

NOTES: (1) Wafer-level tested to 95% confidence level. (2) Positive conventional current flows into the input terminals. (3) See *Small-Signal Overshoot vs Load Capacitance* typical curve.



# ELECTROSTATIC DISCHARGE SENSITIVITY

This integrated circuit can be damaged by ESD. Texas Instruments recommends that all integrated circuits be handled with appropriate precautions. Failure to observe proper handling and installation procedures can cause damage.

ESD damage can range from subtle performance degradation to complete device failure. Precision integrated circuits may be more susceptible to damage because very small parametric changes could cause the device not to meet its published specifications.

## PACKAGE INFORMATION

PRODUCT	PACKAGE	PACKAGE MARKING
<b>Single</b> OPA234EA OPA234E OPA234UA OPA234U	MSOP-8 Surface-Mount " SO-8 Surface-Mount "	A34 " OPA234UA OPA234U
<b>Dual</b> OPA2234UA OPA2234U	SO-8 Surface-Mount "	OPA2234UA OPA2234U
<b>Quad</b> OPA4234UA OPA4234U	SO-8 Surface-Mount "	OPA4234UA OPA4234U

NOTE: (1) For the most current package and ordering information, see the Package Option Addendum located at the end of this data sheet.

## ABSOLUTE MAXIMUM RATINGS

Supply Voltage, V+ to V- .....	36V
Input Voltage .....	(V-) -0.7V to (V+) +0.7V
Output Short-Circuit <sup>(1)</sup> .....	Continuous
Operating Temperature .....	-40°C to +125°C
Storage Temperature .....	-55°C to +125°C
Junction Temperature .....	150°C
Lead Temperature (soldering, 10s) .....	300°C

NOTE: (1) Short-circuit to ground, one amplifier per package.

# TYPICAL CHARACTERISTIC CURVES

At  $T_A = +25^\circ\text{C}$  and  $R_L = 10\text{k}\Omega$ , unless otherwise noted.

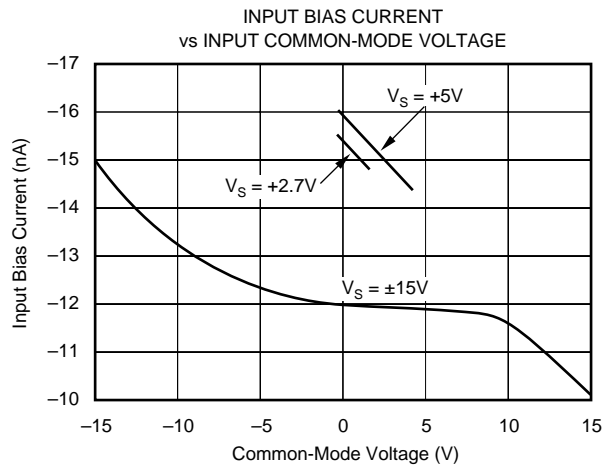
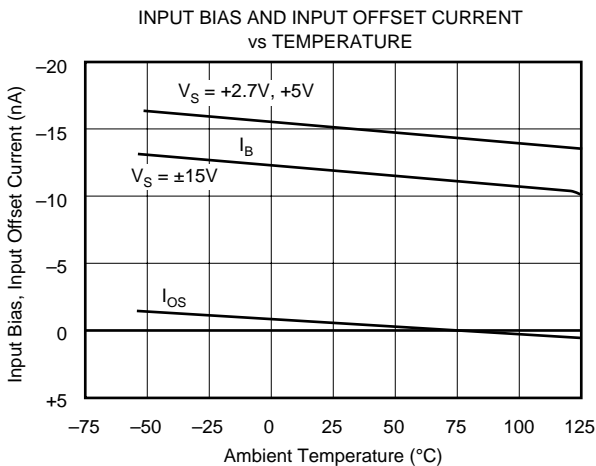
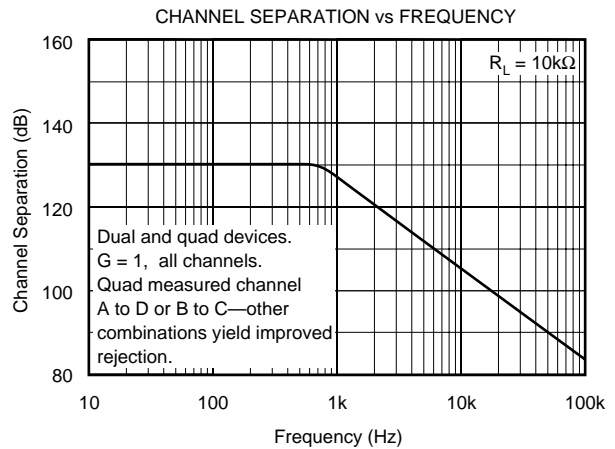
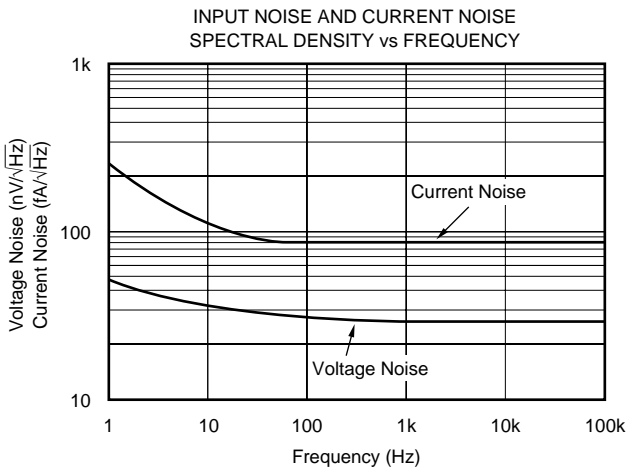
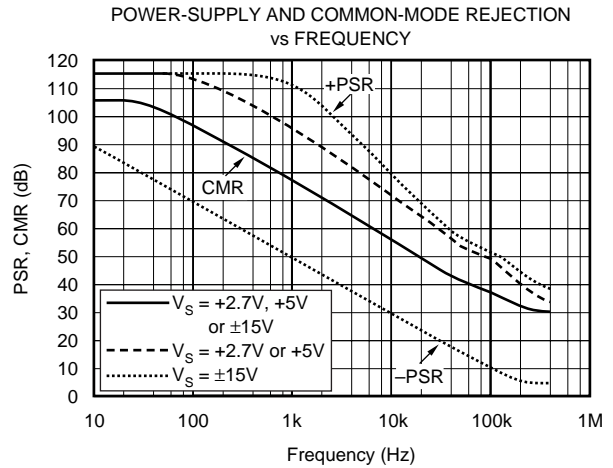
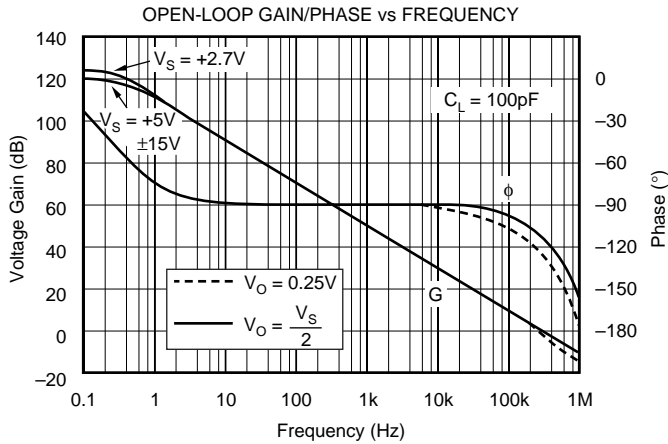

# TYPICAL CHARACTERISTIC CURVES (Cont.)

At  $T_A = +25^\circ\text{C}$  and  $R_L = 10\text{k}\Omega$ , unless otherwise noted.

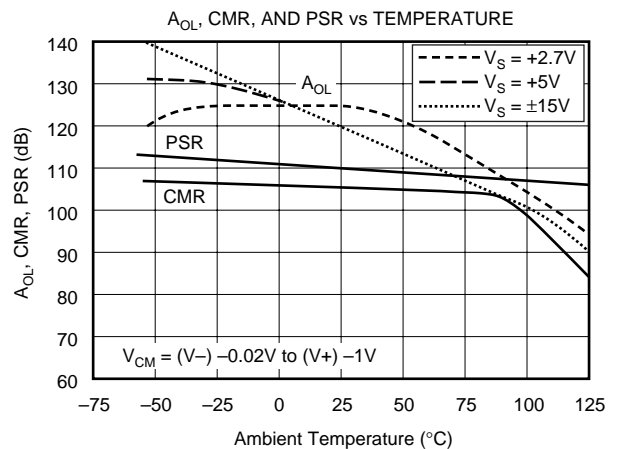
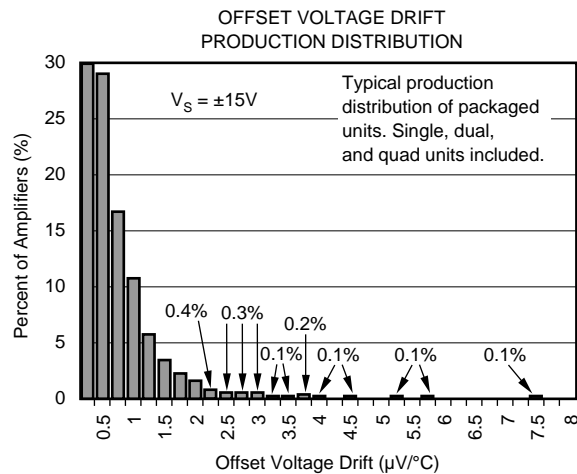
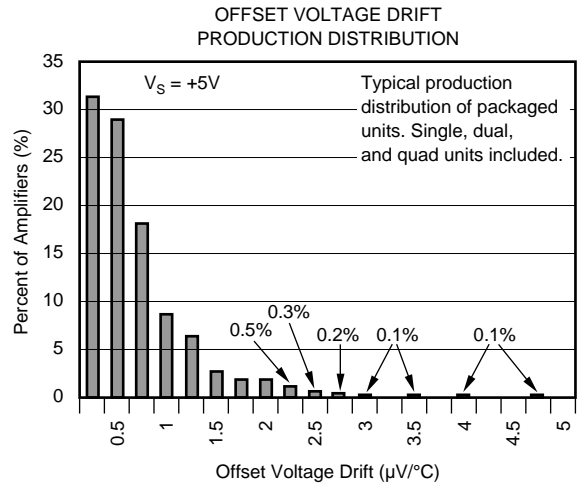
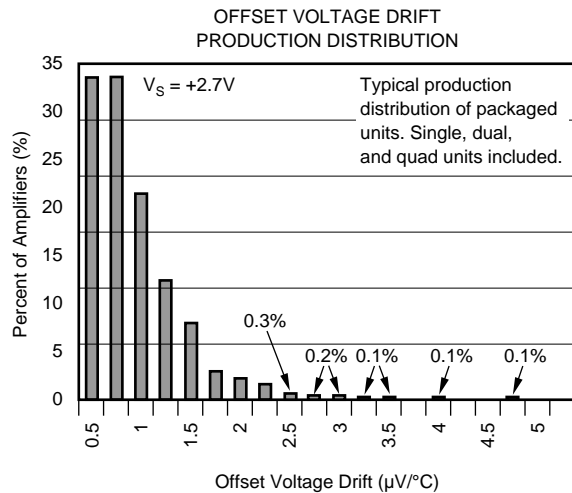
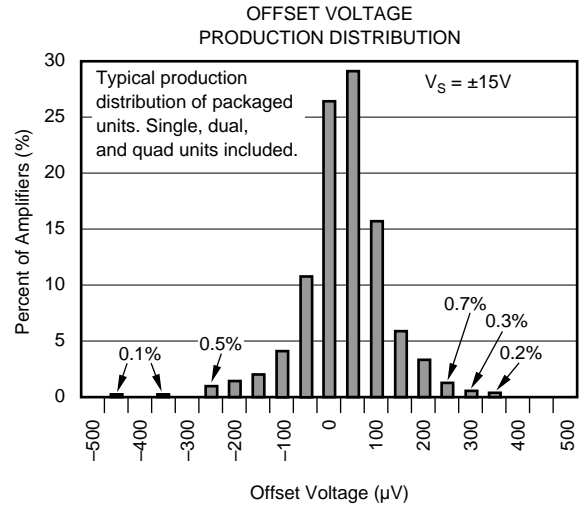
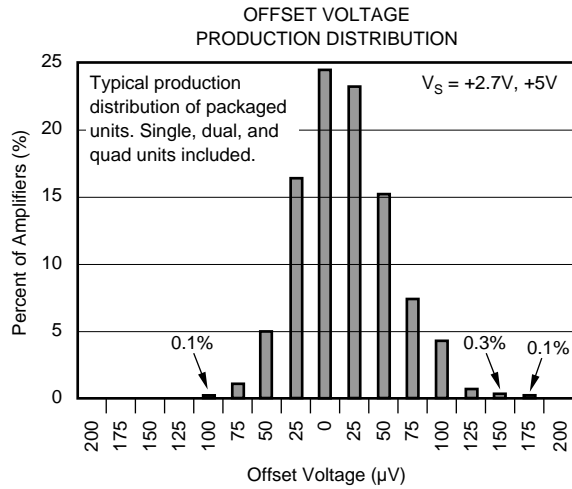

# TYPICAL CHARACTERISTIC CURVES (Cont.)

At  $T_A = +25^\circ\text{C}$  and  $R_L = 10\text{k}\Omega$ , unless otherwise noted.

SMALL-SIGNAL STEP RESPONSE  
 $G = 1$ ,  $C_L = 100\text{pF}$ ,  $V_S = +5\text{V}$

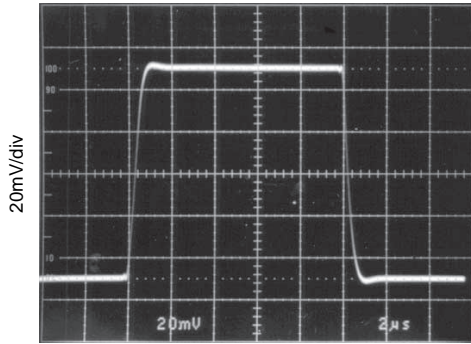

SMALL-SIGNAL STEP RESPONSE  
 $G = 1$ ,  $C_L = 10,000\text{pF}$ ,  $V_S = +5\text{V}$

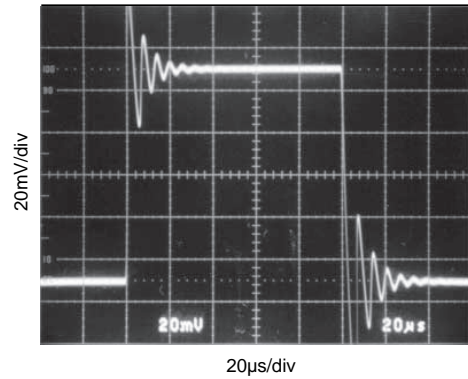

LARGE-SIGNAL STEP RESPONSE  
 $G = 1$ ,  $C_L = 100\text{pF}$ ,  $V_S = +5\text{V}$

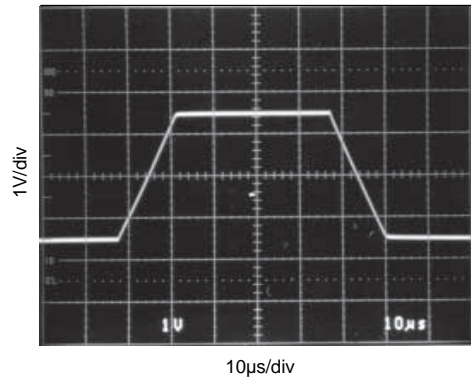

SETTLING TIME vs CLOSED-LOOP GAIN

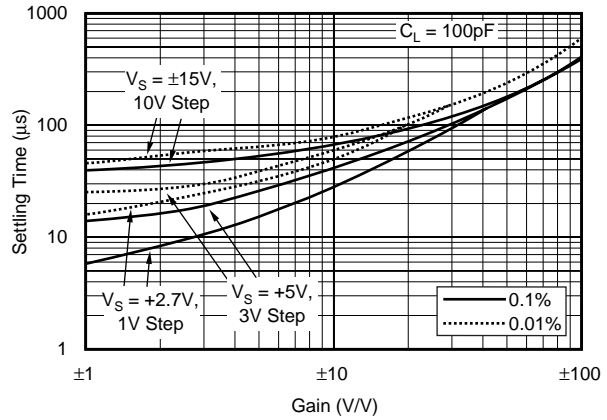

OUTPUT VOLTAGE SWING vs OUTPUT CURRENT

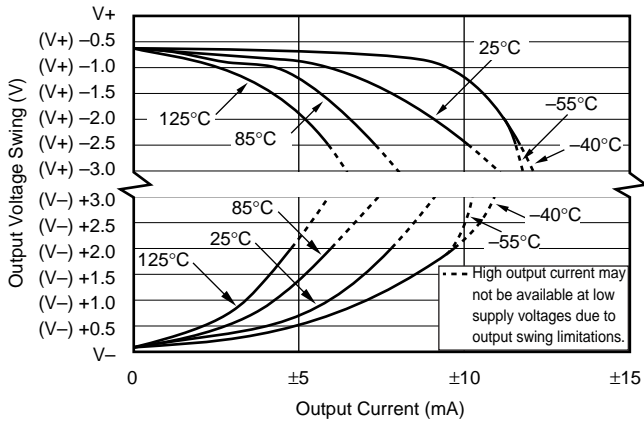

SMALL-SIGNAL OVERSHOOT vs LOAD CAPACITANCE

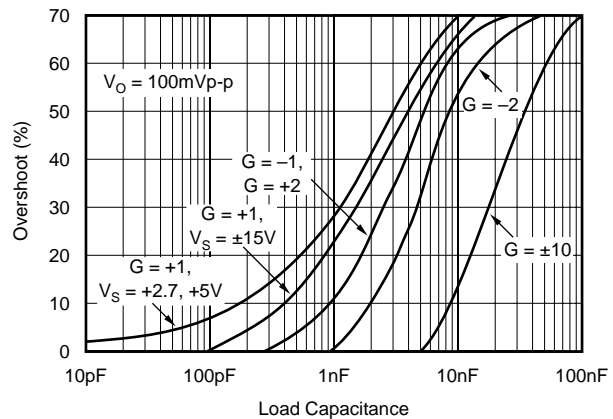



# TYPICAL CHARACTERISTIC CURVES (Cont.)

At  $T_A = +25^\circ\text{C}$  and  $R_L = 10\text{k}\Omega$ , unless otherwise noted.

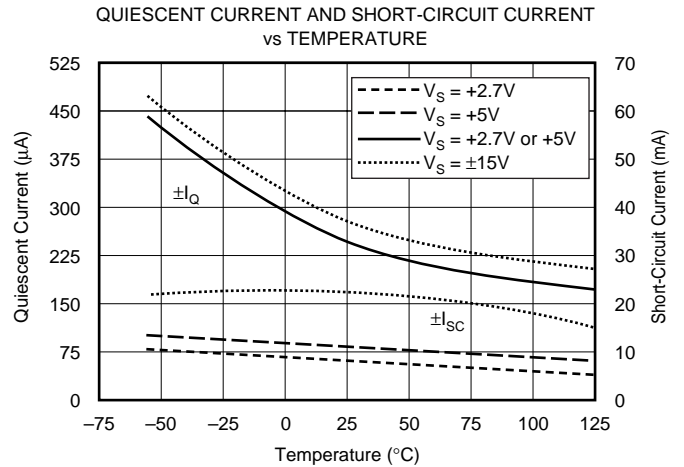
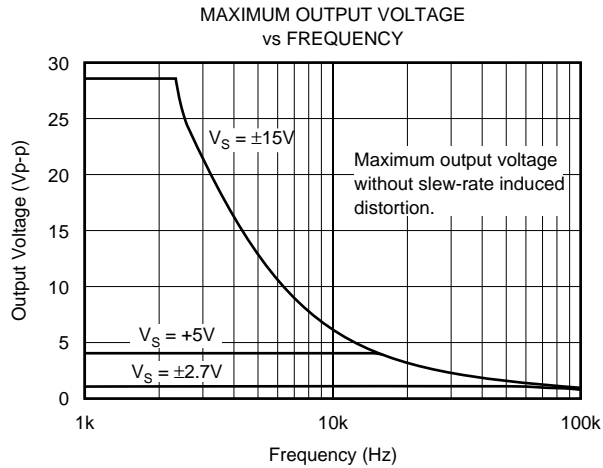

## APPLICATIONS INFORMATION

The OPA234 series op amps are unity-gain stable and suitable for a wide range of general-purpose applications. Power-supply pins should be bypassed with 10nF ceramic capacitors.

### OPERATING VOLTAGE

The OPA234 series op amps operate from single (+2.7V to +36V) or dual ( $\pm 1.35\text{V}$  to  $\pm 18\text{V}$ ) supplies with excellent performance. Specifications are production tested with +2.7V, +5V, and  $\pm 15\text{V}$  supplies. Most behavior remains unchanged throughout the full operating voltage range. Parameters which vary significantly with operating voltage are shown in the Typical Characteristic curves.

### OFFSET VOLTAGE TRIM

Offset voltage of the OPA234 series amplifiers is laser trimmed and usually requires no user adjustment. The OPA234 (single op amp version) provides offset voltage trim connections on pins 1 and 5. Offset voltage can be adjusted by connecting a potentiometer, as shown in Figure 1. This adjustment should be used only to null the offset of the op amp, not to adjust system offset or offset produced by the signal source. Nulling offset could degrade the offset drift behavior of the op amp. While it is not possible to predict the exact change in drift, the effect is usually small.

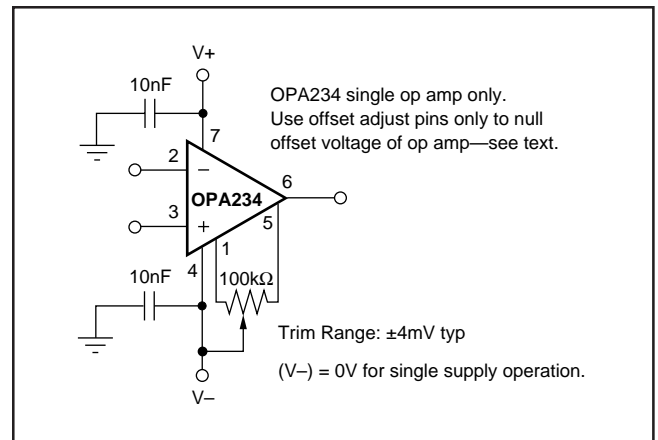

FIGURE 1. OPA234 Offset Voltage Trim Circuit.

**PACKAGING INFORMATION**

Orderable Device	Status <sup>(1)</sup>	Package Type	Package Drawing	Pins	Package Qty	Eco Plan <sup>(2)</sup>	Lead/Ball Finish	MSL Peak Temp <sup>(3)</sup>
OPA2234P	OBSOLETE	PDIP	P	8		TBD	Call TI	Call TI
OPA2234PA	OBSOLETE	PDIP	P	8		TBD	Call TI	Call TI
OPA2234U	ACTIVE	SOIC	D	8	100	Green (RoHS & no Sb/Br)	CU NIPDAU	Level-3-260C-168 HR
OPA2234U-2/2K5	OBSOLETE	SOIC	D	8		TBD	Call TI	Call TI
OPA2234U/2K5	ACTIVE	SOIC	D	8	2500	Green (RoHS & no Sb/Br)	CU NIPDAU	Level-3-260C-168 HR
OPA2234U/2K5E4	PREVIEW	SOIC	D	8		TBD	Call TI	Call TI
OPA2234U/2K5G4	ACTIVE	SOIC	D	8	2500	Green (RoHS & no Sb/Br)	CU NIPDAU	Level-3-260C-168 HR
OPA2234UA	ACTIVE	SOIC	D	8	100	Green (RoHS & no Sb/Br)	CU NIPDAU	Level-3-260C-168 HR
OPA2234UA/2K5	ACTIVE	SOIC	D	8	2500	Green (RoHS & no Sb/Br)	CU NIPDAU	Level-3-260C-168 HR
OPA2234UA/2K5E4	PREVIEW	SOIC	D	8		TBD	Call TI	Call TI
OPA2234UA/2K5G4	ACTIVE	SOIC	D	8	2500	Green (RoHS & no Sb/Br)	CU NIPDAU	Level-3-260C-168 HR
OPA2234UAE4	PREVIEW	SOIC	D	8		TBD	Call TI	Call TI
OPA2234UAG4	ACTIVE	SOIC	D	8	100	Green (RoHS & no Sb/Br)	CU NIPDAU	Level-3-260C-168 HR
OPA2234UE4	PREVIEW	SOIC	D	8		TBD	Call TI	Call TI
OPA2234UG4	ACTIVE	SOIC	D	8	100	Green (RoHS & no Sb/Br)	CU NIPDAU	Level-3-260C-168 HR
OPA234E/250	ACTIVE	MSOP	DGK	8	250	Green (RoHS & no Sb/Br)	CU NIPDAU	Level-3-260C-168 HR
OPA234E/250E4	PREVIEW	MSOP	DGK	8	250	TBD	Call TI	Call TI
OPA234E/250G4	ACTIVE	MSOP	DGK	8	250	Green (RoHS & no Sb/Br)	CU NIPDAU	Level-3-260C-168 HR
OPA234E/2K5	ACTIVE	MSOP	DGK	8	2500	Green (RoHS & no Sb/Br)	CU NIPDAU	Level-3-260C-168 HR
OPA234E/2K5E4	PREVIEW	MSOP	DGK	8	2500	TBD	Call TI	Call TI
OPA234E/2K5G4	ACTIVE	MSOP	DGK	8	2500	Green (RoHS & no Sb/Br)	CU NIPDAU	Level-3-260C-168 HR
OPA234EA/250	ACTIVE	MSOP	DGK	8	250	Green (RoHS & no Sb/Br)	CU NIPDAU	Level-3-260C-168 HR
OPA234EA/250E4	PREVIEW	MSOP	DGK	8	250	TBD	Call TI	Call TI
OPA234EA/250G4	ACTIVE	MSOP	DGK	8	250	Green (RoHS & no Sb/Br)	CU NIPDAU	Level-3-260C-168 HR
OPA234EA/2K5	ACTIVE	MSOP	DGK	8	2500	Green (RoHS & no Sb/Br)	CU NIPDAU	Level-3-260C-168 HR
OPA234EA/2K5E4	PREVIEW	MSOP	DGK	8	2500	TBD	Call TI	Call TI
OPA234EA/2K5G4	ACTIVE	MSOP	DGK	8	2500	Green (RoHS & no Sb/Br)	CU NIPDAU	Level-3-260C-168 HR
OPA234P	OBSOLETE	PDIP	P	8		TBD	Call TI	Call TI
OPA234PA	OBSOLETE	PDIP	P	8		TBD	Call TI	Call TI
OPA234U	ACTIVE	SOIC	D	8	100	Green (RoHS & no Sb/Br)	CU NIPDAU	Level-3-260C-168 HR

Orderable Device	Status <sup>(1)</sup>	Package Type	Package Drawing	Pins	Package Qty	Eco Plan <sup>(2)</sup>	Lead/Ball Finish	MSL Peak Temp <sup>(3)</sup>
OPA234U/2K5	ACTIVE	SOIC	D	8	2500	Green (RoHS & no Sb/Br)	CU NIPDAU	Level-3-260C-168 HR
OPA234U/2K5E4	ACTIVE	SOIC	D	8	2500	Green (RoHS & no Sb/Br)	CU NIPDAU	Level-3-260C-168 HR
OPA234UA	ACTIVE	SOIC	D	8	100	Green (RoHS & no Sb/Br)	CU NIPDAU	Level-3-260C-168 HR
OPA234UA/2K5	ACTIVE	SOIC	D	8	2500	Green (RoHS & no Sb/Br)	CU NIPDAU	Level-3-260C-168 HR
OPA234UA/2K5E4	PREVIEW	SOIC	D	8		TBD	Call TI	Call TI
OPA234UA/2K5G4	ACTIVE	SOIC	D	8	2500	Green (RoHS & no Sb/Br)	CU NIPDAU	Level-3-260C-168 HR
OPA234UAE4	PREVIEW	SOIC	D	8		TBD	Call TI	Call TI
OPA234UAG4	ACTIVE	SOIC	D	8		TBD	Call TI	Call TI
OPA234UG4	ACTIVE	SOIC	D	8	100	Green (RoHS & no Sb/Br)	CU NIPDAU	Level-3-260C-168 HR
OPA4234PA	OBSOLETE	PDIP	N	14		TBD	Call TI	Call TI
OPA4234U	ACTIVE	SOIC	D	14	58	Green (RoHS & no Sb/Br)	CU NIPDAU	Level-3-260C-168 HR
OPA4234U/2K5	ACTIVE	SOIC	D	14	2500	Green (RoHS & no Sb/Br)	CU NIPDAU	Level-3-260C-168 HR
OPA4234U/2K5E4	PREVIEW	SOIC	D	14		TBD	Call TI	Call TI
OPA4234U/2K5G4	ACTIVE	SOIC	D	14	2500	Green (RoHS & no Sb/Br)	CU NIPDAU	Level-3-260C-168 HR
OPA4234UA	ACTIVE	SOIC	D	14	58	Green (RoHS & no Sb/Br)	CU NIPDAU	Level-3-260C-168 HR
OPA4234UA/2K5	ACTIVE	SOIC	D	14	2500	Green (RoHS & no Sb/Br)	CU NIPDAU	Level-3-260C-168 HR
OPA4234UA/2K5E4	PREVIEW	SOIC	D	14		TBD	Call TI	Call TI
OPA4234UA/2K5G4	ACTIVE	SOIC	D	14	2500	Green (RoHS & no Sb/Br)	CU NIPDAU	Level-3-260C-168 HR
OPA4234UAE4	PREVIEW	SOIC	D	14		TBD	Call TI	Call TI
OPA4234UAG4	ACTIVE	SOIC	D	14	58	Green (RoHS & no Sb/Br)	CU NIPDAU	Level-3-260C-168 HR
OPA4234UE4	PREVIEW	SOIC	D	14		TBD	Call TI	Call TI
OPA4234UG4	ACTIVE	SOIC	D	14	58	Green (RoHS & no Sb/Br)	CU NIPDAU	Level-3-260C-168 HR

<sup>(1)</sup> The marketing status values are defined as follows:

**ACTIVE:** Product device recommended for new designs.

**LIFEBUY:** TI has announced that the device will be discontinued, and a lifetime-buy period is in effect.

**NRND:** Not recommended for new designs. Device is in production to support existing customers, but TI does not recommend using this part in a new design.

**PREVIEW:** Device has been announced but is not in production. Samples may or may not be available.

**OBSOLETE:** TI has discontinued the production of the device.

<sup>(2)</sup> Eco Plan - The planned eco-friendly classification: Pb-Free (RoHS), Pb-Free (RoHS Exempt), or Green (RoHS & no Sb/Br) - please check <http://www.ti.com/productcontent> for the latest availability information and additional product content details.

**TBD:** The Pb-Free/Green conversion plan has not been defined.

**Pb-Free (RoHS):** TI's terms "Lead-Free" or "Pb-Free" mean semiconductor products that are compatible with the current RoHS requirements for all 6 substances, including the requirement that lead not exceed 0.1% by weight in homogeneous materials. Where designed to be soldered at high temperatures, TI Pb-Free products are suitable for use in specified lead-free processes.

**Pb-Free (RoHS Exempt):** This component has a RoHS exemption for either 1) lead-based flip-chip solder bumps used between the die and package, or 2) lead-based die adhesive used between the die and leadframe. The component is otherwise considered Pb-Free (RoHS

compatible) as defined above.

**Green (RoHS & no Sb/Br):** TI defines "Green" to mean Pb-Free (RoHS compatible), and free of Bromine (Br) and Antimony (Sb) based flame retardants (Br or Sb do not exceed 0.1% by weight in homogeneous material)

<sup>(3)</sup> MSL, Peak Temp. -- The Moisture Sensitivity Level rating according to the JEDEC industry standard classifications, and peak solder temperature.

**Important Information and Disclaimer:**The information provided on this page represents TI's knowledge and belief as of the date that it is provided. TI bases its knowledge and belief on information provided by third parties, and makes no representation or warranty as to the accuracy of such information. Efforts are underway to better integrate information from third parties. TI has taken and continues to take reasonable steps to provide representative and accurate information but may not have conducted destructive testing or chemical analysis on incoming materials and chemicals. TI and TI suppliers consider certain information to be proprietary, and thus CAS numbers and other limited information may not be available for release.

In no event shall TI's liability arising out of such information exceed the total purchase price of the TI part(s) at issue in this document sold by TI to Customer on an annual basis.

**TAPE AND REEL INFORMATION**



**QUADRANT ASSIGNMENTS FOR PIN 1 ORIENTATION IN TAPE**



\*All dimensions are nominal

Device	Package Type	Package Drawing	Pins	SPQ	Reel Diameter (mm)	Reel Width W1 (mm)	A0 (mm)	B0 (mm)	K0 (mm)	P1 (mm)	W (mm)	Pin1 Quadrant
OPA2234U/2K5	SOIC	D	8	2500	330.0	12.4	6.4	5.2	2.1	8.0	12.0	Q1
OPA2234UA/2K5	SOIC	D	8	2500	330.0	12.4	6.4	5.2	2.1	8.0	12.0	Q1
OPA234E/250	MSOP	DGK	8	250	180.0	12.4	5.3	3.4	1.4	8.0	12.0	Q1
OPA234E/2K5	MSOP	DGK	8	2500	330.0	12.4	5.3	3.4	1.4	8.0	12.0	Q1
OPA234EA/250	MSOP	DGK	8	250	180.0	12.4	5.3	3.4	1.4	8.0	12.0	Q1
OPA234EA/2K5	MSOP	DGK	8	2500	330.0	12.4	5.3	3.4	1.4	8.0	12.0	Q1
OPA234U/2K5	SOIC	D	8	2500	330.0	12.4	6.4	5.2	2.1	8.0	12.0	Q1
OPA234UA/2K5	SOIC	D	8	2500	330.0	12.4	6.4	5.2	2.1	8.0	12.0	Q1
OPA4234U/2K5	SOIC	D	14	2500	330.0	16.4	6.5	9.0	2.1	8.0	16.0	Q1
OPA4234UA/2K5	SOIC	D	14	2500	330.0	16.4	6.5	9.0	2.1	8.0	16.0	Q1

**TAPE AND REEL BOX DIMENSIONS**



\*All dimensions are nominal

Device	Package Type	Package Drawing	Pins	SPQ	Length (mm)	Width (mm)	Height (mm)
OPA2234U/2K5	SOIC	D	8	2500	346.0	346.0	29.0
OPA2234UA/2K5	SOIC	D	8	2500	346.0	346.0	29.0
OPA234E/250	MSOP	DGK	8	250	184.0	184.0	50.0
OPA234E/2K5	MSOP	DGK	8	2500	346.0	346.0	29.0
OPA234EA/250	MSOP	DGK	8	250	184.0	184.0	50.0
OPA234EA/2K5	MSOP	DGK	8	2500	346.0	346.0	29.0
OPA234U/2K5	SOIC	D	8	2500	346.0	346.0	29.0
OPA234UA/2K5	SOIC	D	8	2500	346.0	346.0	29.0
OPA4234U/2K5	SOIC	D	14	2500	346.0	346.0	33.0
OPA4234UA/2K5	SOIC	D	14	2500	346.0	346.0	33.0



D (R-PDSO-G8)

PLASTIC SMALL-OUTLINE PACKAGE

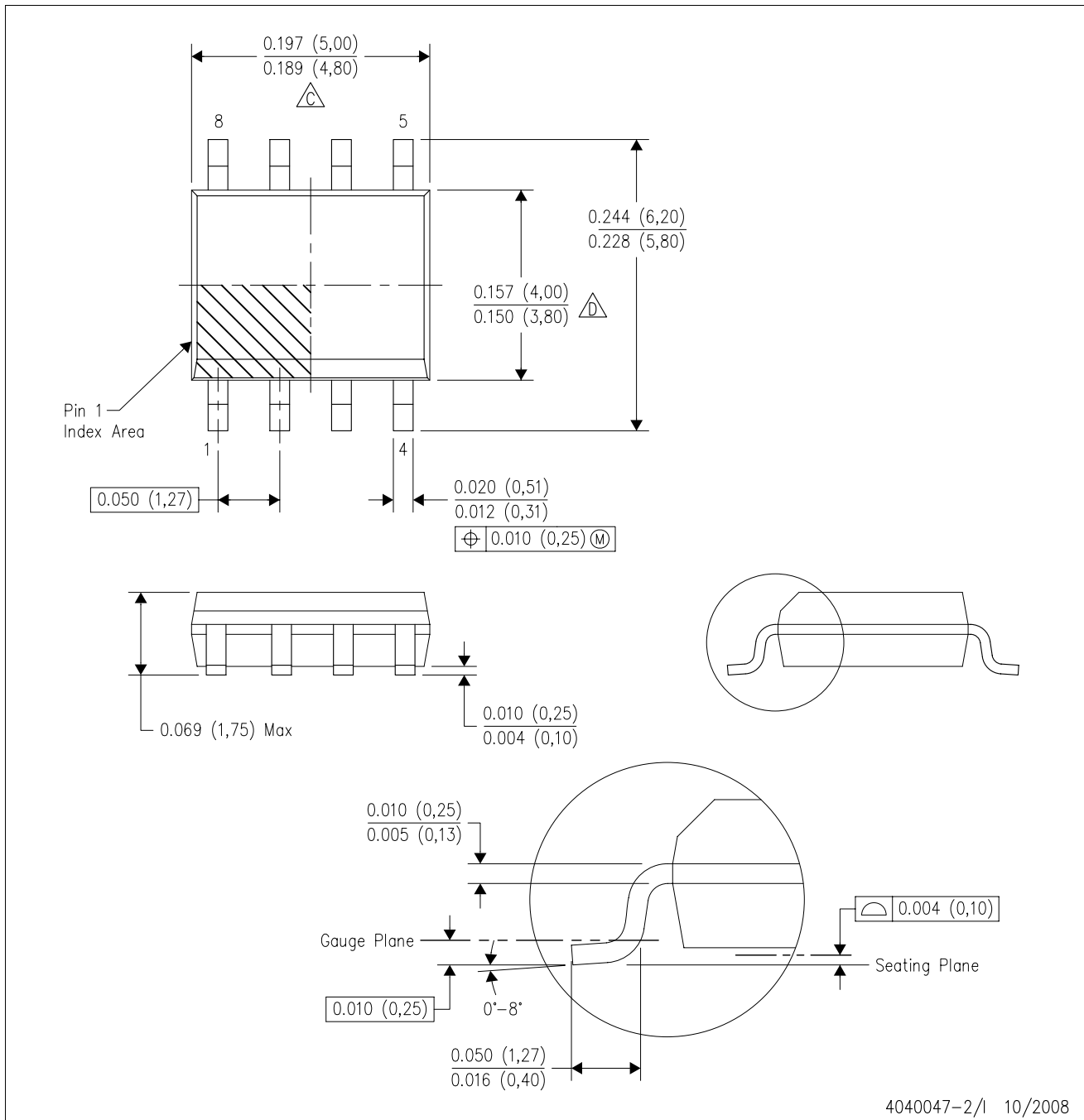

- NOTES:
- A. All linear dimensions are in inches (millimeters).
  - B. This drawing is subject to change without notice.
  - $\triangle C$  Body length does not include mold flash, protrusions, or gate burrs. Mold flash, protrusions, or gate burrs shall not exceed .006 (0,15) per end.
  - $\triangle D$  Body width does not include interlead flash. Interlead flash shall not exceed .017 (0,43) per side.
  - E. Reference JEDEC MS-012 variation AA.



D (R-PDSO-G14)

PLASTIC SMALL-OUTLINE PACKAGE

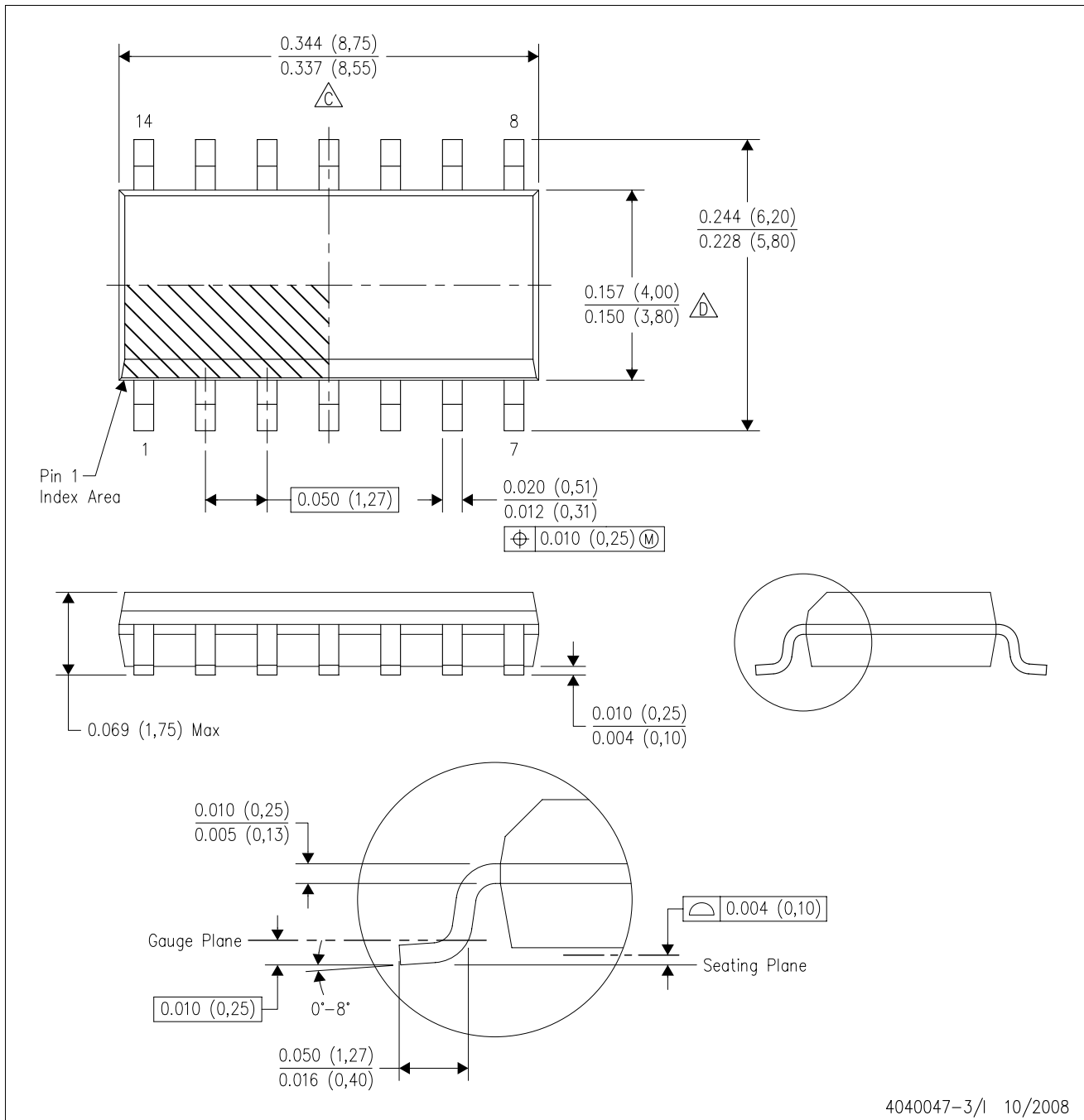

- NOTES:
- A. All linear dimensions are in inches (millimeters).
  - B. This drawing is subject to change without notice.
  - $\triangle C$  Body length does not include mold flash, protrusions, or gate burrs. Mold flash, protrusions, or gate burrs shall not exceed .006 (0,15) per end.
  - $\triangle D$  Body width does not include interlead flash. Interlead flash shall not exceed .017 (0,43) per side.
  - E. Reference JEDEC MS-012 variation AB.

P (R-PDIP-T8)

PLASTIC DUAL-IN-LINE



- NOTES: A. All linear dimensions are in inches (millimeters).  
 B. This drawing is subject to change without notice.  
 C. Falls within JEDEC MS-001

For the latest package information, go to [http://www.ti.com/sc/docs/package/pkg\\_info.htm](http://www.ti.com/sc/docs/package/pkg_info.htm)



## IMPORTANT NOTICE

Texas Instruments Incorporated and its subsidiaries (TI) reserve the right to make corrections, modifications, enhancements, improvements, and other changes to its products and services at any time and to discontinue any product or service without notice. Customers should obtain the latest relevant information before placing orders and should verify that such information is current and complete. All products are sold subject to TI's terms and conditions of sale supplied at the time of order acknowledgment.

TI warrants performance of its hardware products to the specifications applicable at the time of sale in accordance with TI's standard warranty. Testing and other quality control techniques are used to the extent TI deems necessary to support this warranty. Except where mandated by government requirements, testing of all parameters of each product is not necessarily performed.

TI assumes no liability for applications assistance or customer product design. Customers are responsible for their products and applications using TI components. To minimize the risks associated with customer products and applications, customers should provide adequate design and operating safeguards.

TI does not warrant or represent that any license, either express or implied, is granted under any TI patent right, copyright, mask work right, or other TI intellectual property right relating to any combination, machine, or process in which TI products or services are used. Information published by TI regarding third-party products or services does not constitute a license from TI to use such products or services or a warranty or endorsement thereof. Use of such information may require a license from a third party under the patents or other intellectual property of the third party, or a license from TI under the patents or other intellectual property of TI.

Reproduction of TI information in TI data books or data sheets is permissible only if reproduction is without alteration and is accompanied by all associated warranties, conditions, limitations, and notices. Reproduction of this information with alteration is an unfair and deceptive business practice. TI is not responsible or liable for such altered documentation. Information of third parties may be subject to additional restrictions.

Resale of TI products or services with statements different from or beyond the parameters stated by TI for that product or service voids all express and any implied warranties for the associated TI product or service and is an unfair and deceptive business practice. TI is not responsible or liable for any such statements.

TI products are not authorized for use in safety-critical applications (such as life support) where a failure of the TI product would reasonably be expected to cause severe personal injury or death, unless officers of the parties have executed an agreement specifically governing such use. Buyers represent that they have all necessary expertise in the safety and regulatory ramifications of their applications, and acknowledge and agree that they are solely responsible for all legal, regulatory and safety-related requirements concerning their products and any use of TI products in such safety-critical applications, notwithstanding any applications-related information or support that may be provided by TI. Further, Buyers must fully indemnify TI and its representatives against any damages arising out of the use of TI products in such safety-critical applications.

TI products are neither designed nor intended for use in military/aerospace applications or environments unless the TI products are specifically designated by TI as military-grade or "enhanced plastic." Only products designated by TI as military-grade meet military specifications. Buyers acknowledge and agree that any such use of TI products which TI has not designated as military-grade is solely at the Buyer's risk, and that they are solely responsible for compliance with all legal and regulatory requirements in connection with such use.

TI products are neither designed nor intended for use in automotive applications or environments unless the specific TI products are designated by TI as compliant with ISO/TS 16949 requirements. Buyers acknowledge and agree that, if they use any non-designated products in automotive applications, TI will not be responsible for any failure to meet such requirements.

Following are URLs where you can obtain information on other Texas Instruments products and application solutions:

### Products

Amplifiers	<a href="http://amplifier.ti.com">amplifier.ti.com</a>
Data Converters	<a href="http://dataconverter.ti.com">dataconverter.ti.com</a>
DSP	<a href="http://dsp.ti.com">dsp.ti.com</a>
Clocks and Timers	<a href="http://www.ti.com/clocks">www.ti.com/clocks</a>
Interface	<a href="http://interface.ti.com">interface.ti.com</a>
Logic	<a href="http://logic.ti.com">logic.ti.com</a>
Power Mgmt	<a href="http://power.ti.com">power.ti.com</a>
Microcontrollers	<a href="http://microcontroller.ti.com">microcontroller.ti.com</a>
RFID	<a href="http://www.ti-rfid.com">www.ti-rfid.com</a>
RF/IF and ZigBee® Solutions	<a href="http://www.ti.com/lprf">www.ti.com/lprf</a>

### Applications

Audio	<a href="http://www.ti.com/audio">www.ti.com/audio</a>
Automotive	<a href="http://www.ti.com/automotive">www.ti.com/automotive</a>
Broadband	<a href="http://www.ti.com/broadband">www.ti.com/broadband</a>
Digital Control	<a href="http://www.ti.com/digitalcontrol">www.ti.com/digitalcontrol</a>
Medical	<a href="http://www.ti.com/medical">www.ti.com/medical</a>
Military	<a href="http://www.ti.com/military">www.ti.com/military</a>
Optical Networking	<a href="http://www.ti.com/opticalnetwork">www.ti.com/opticalnetwork</a>
Security	<a href="http://www.ti.com/security">www.ti.com/security</a>
Telephony	<a href="http://www.ti.com/telephony">www.ti.com/telephony</a>
Video & Imaging	<a href="http://www.ti.com/video">www.ti.com/video</a>
Wireless	<a href="http://www.ti.com/wireless">www.ti.com/wireless</a>

Mailing Address: Texas Instruments, Post Office Box 655303, Dallas, Texas 75265  
Copyright © 2008, Texas Instruments Incorporated